

Velkommen som seiler!

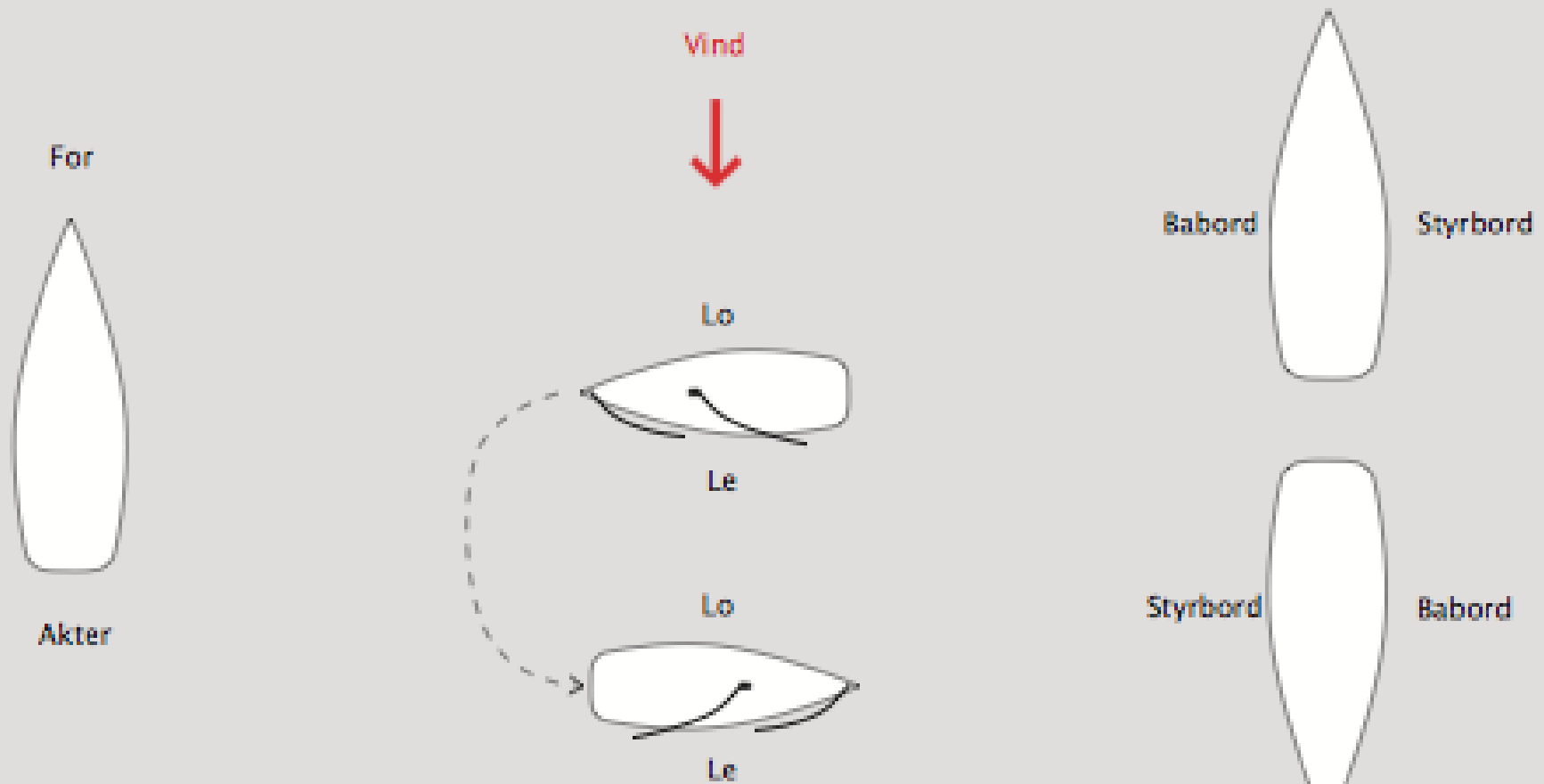

Retninger til sjøs



Vind



Vindøyet/Slag

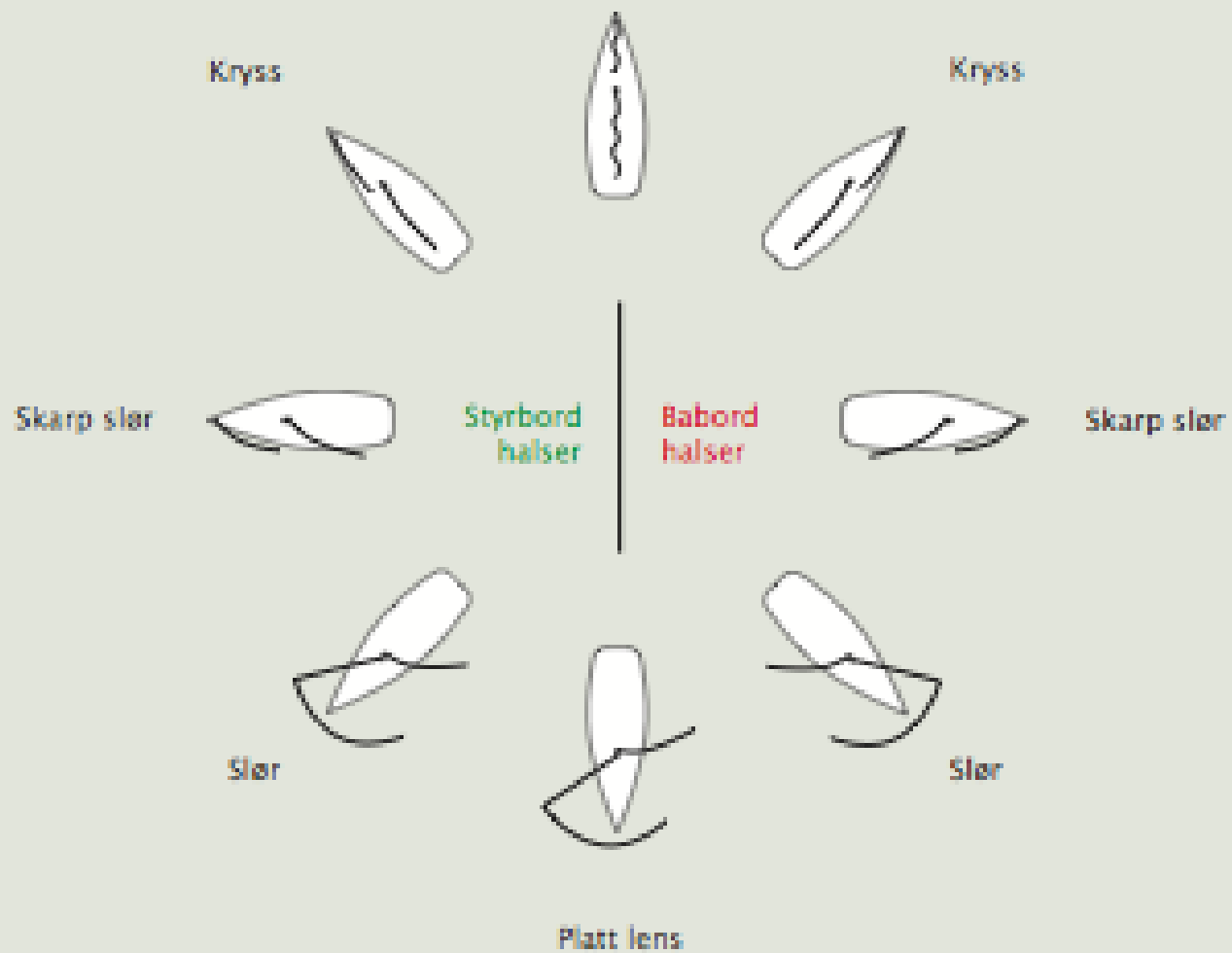

Storseil



Fokk/Genoa



Spinnaker



Gennaker





⌘ Fall



⌘ Skjøter



⌘ Trimliner



Hva gjør man?



Vind



Seile mot vinden?

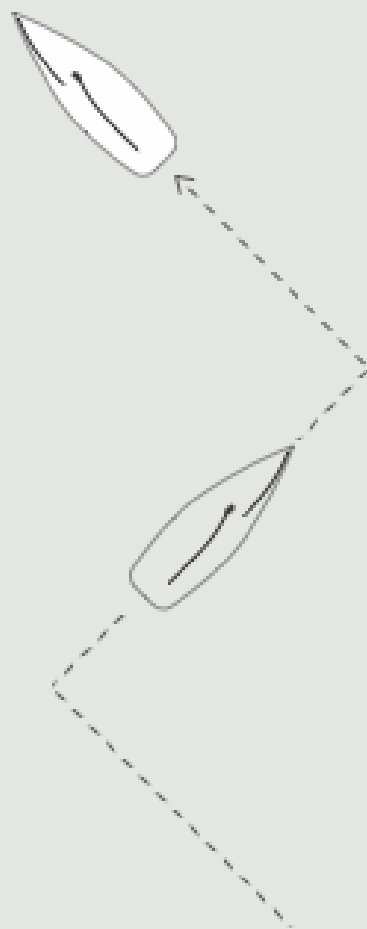

Kryssvinkel

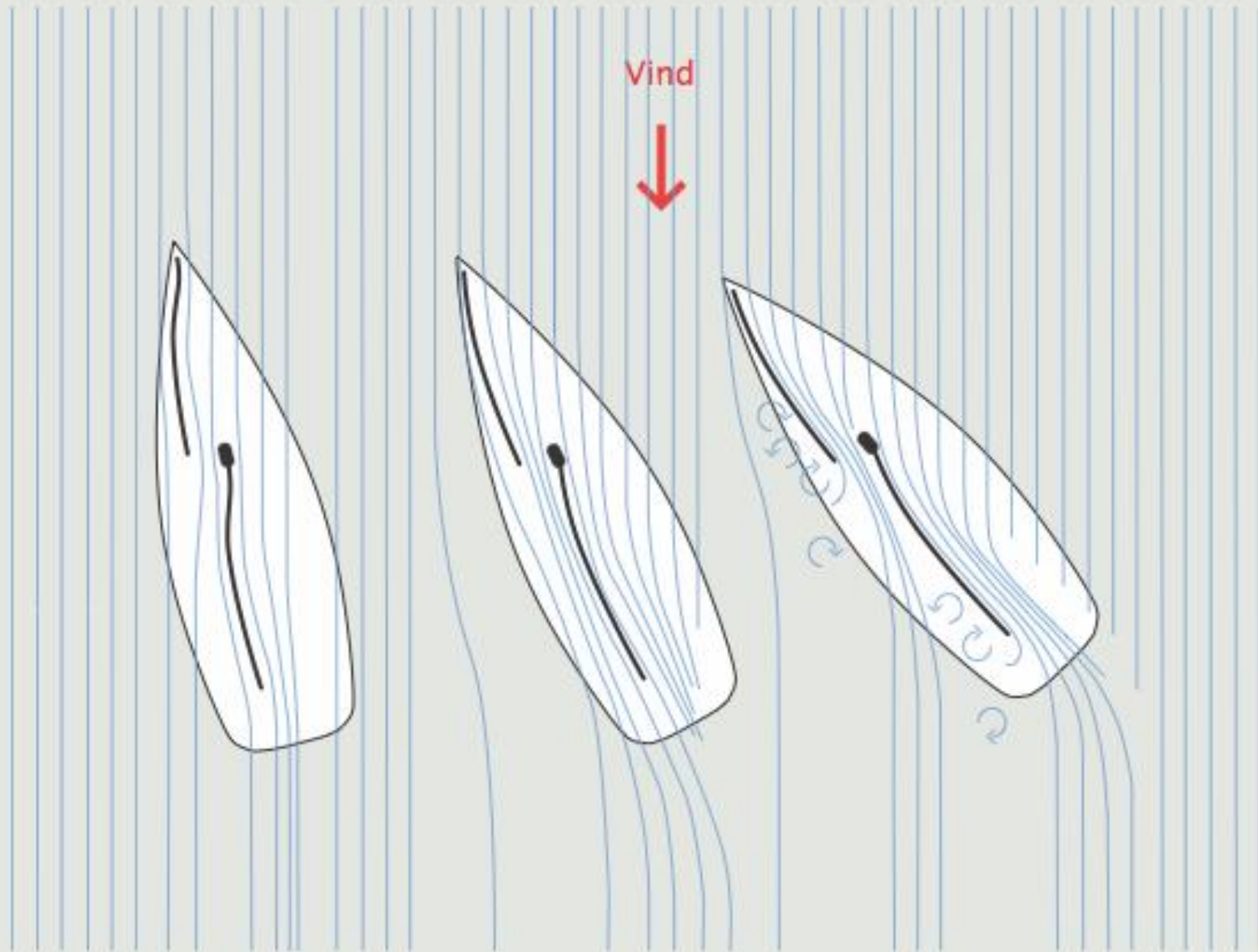

Styre eller skjøte?

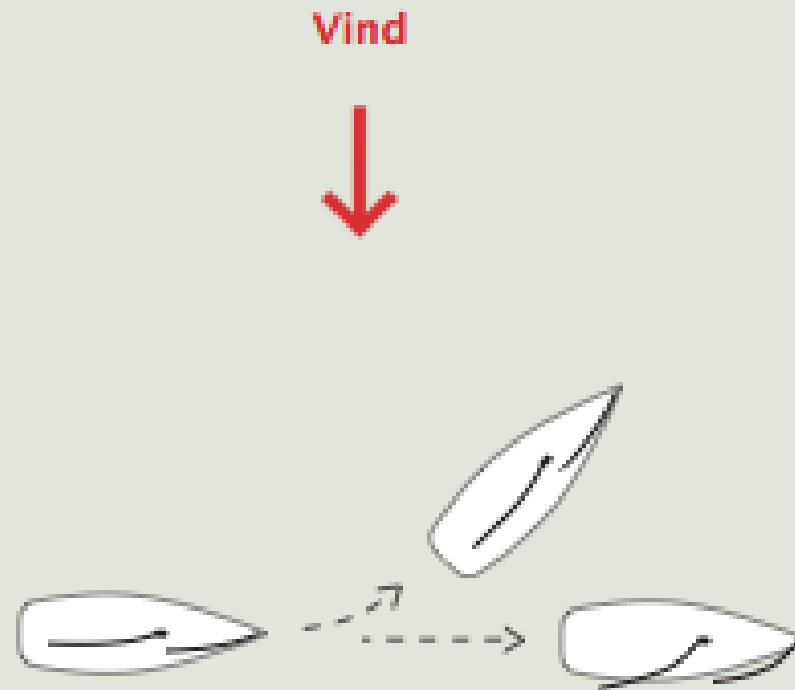

Hva er Lus?



Styr etter lusene:

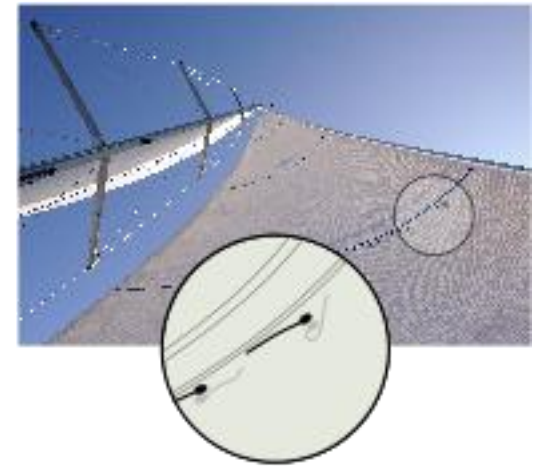
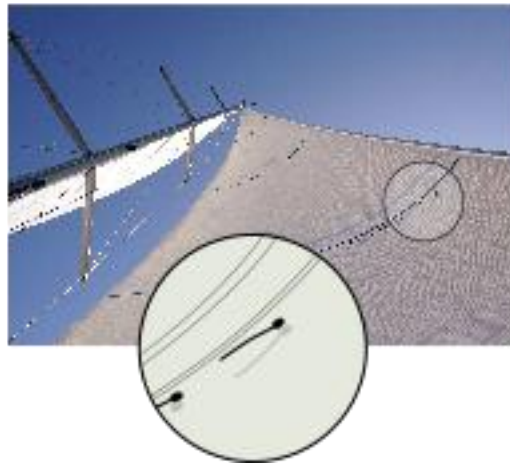
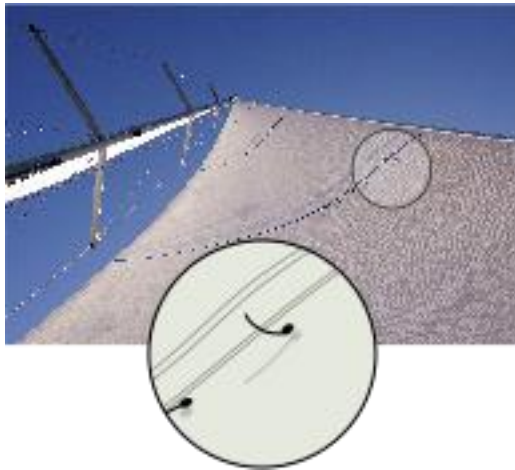

Laminær luftstrøm

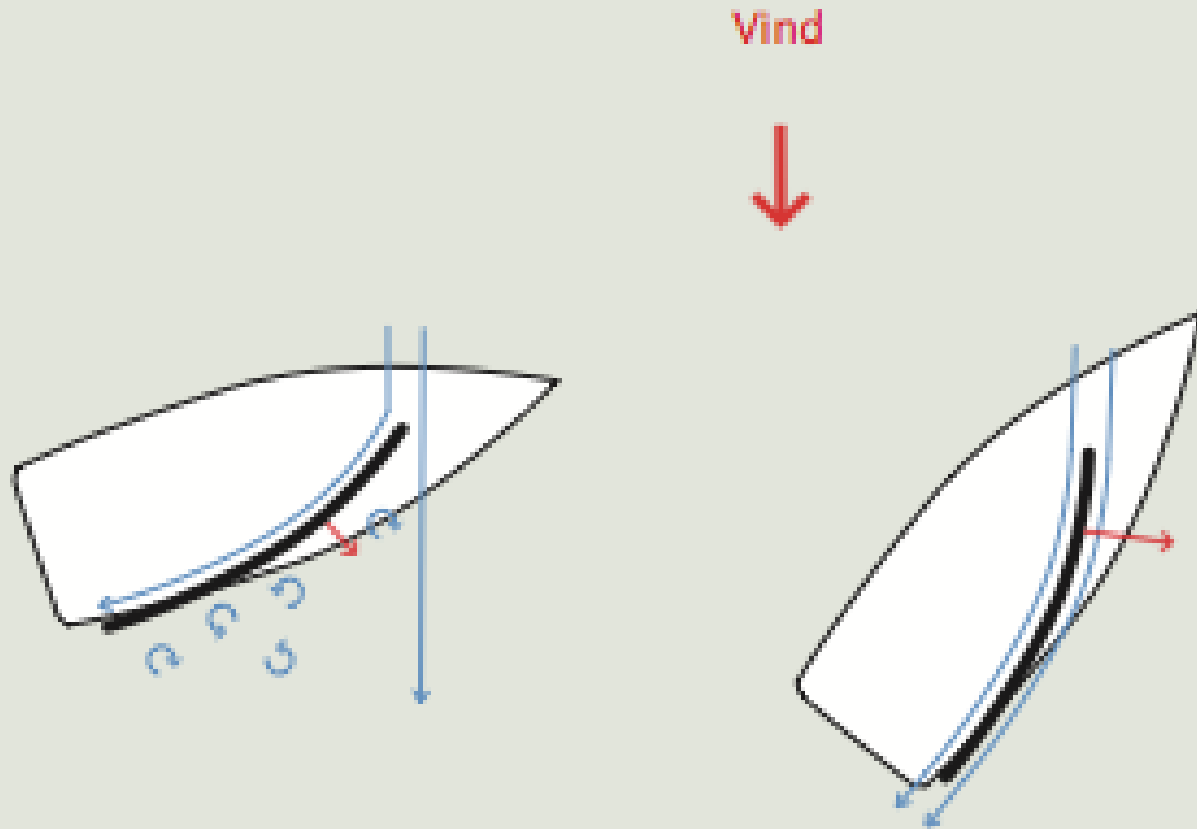

Fart vs. høyde

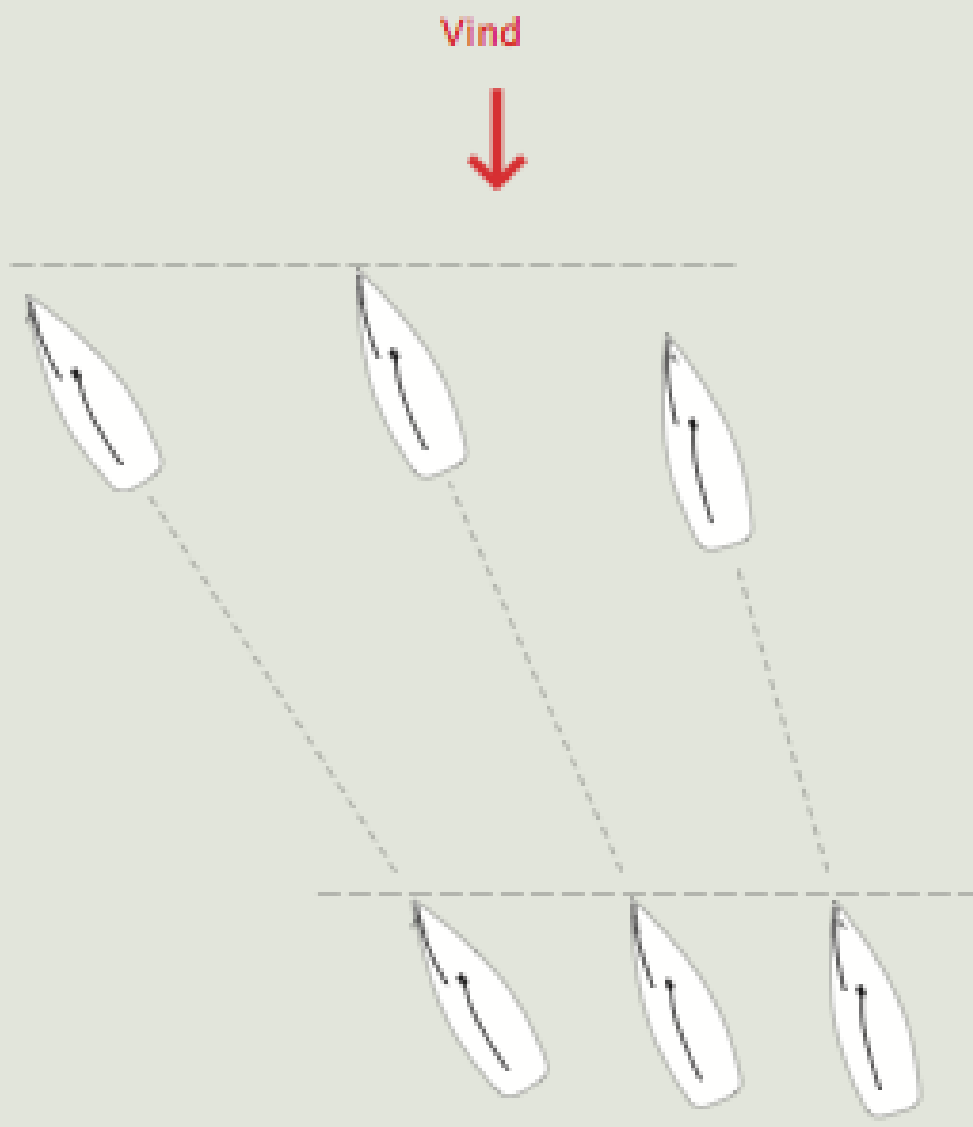

Hva heter det?



Vind



Babord halser

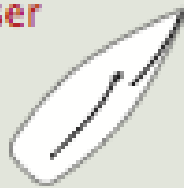

Styrbord halser

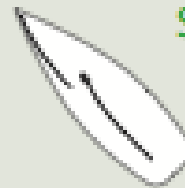

Vind



Loffe

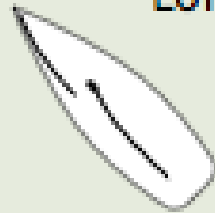

Falle av



Slag

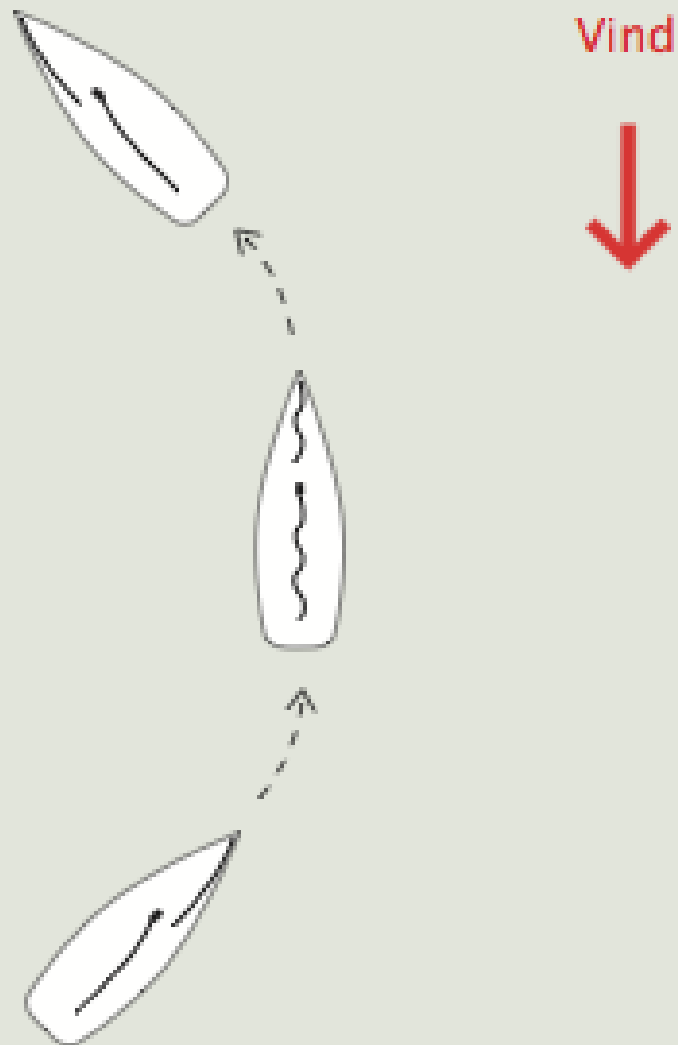

Vind



Slør

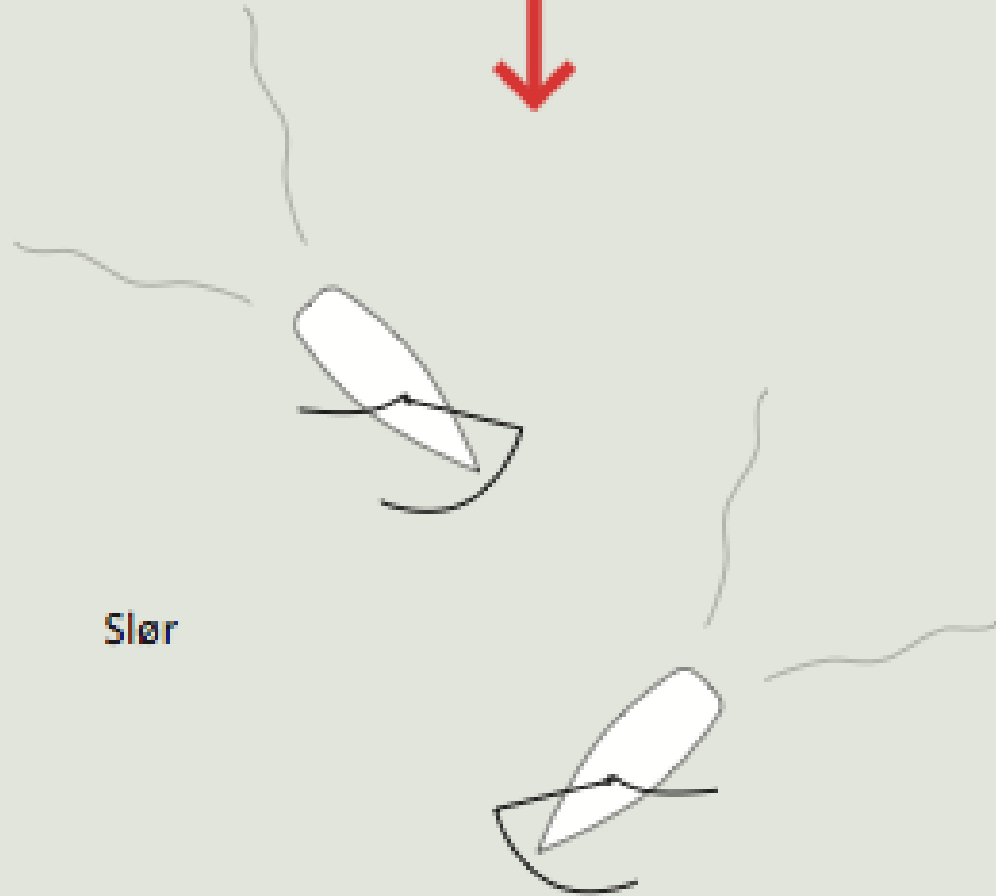

Vind

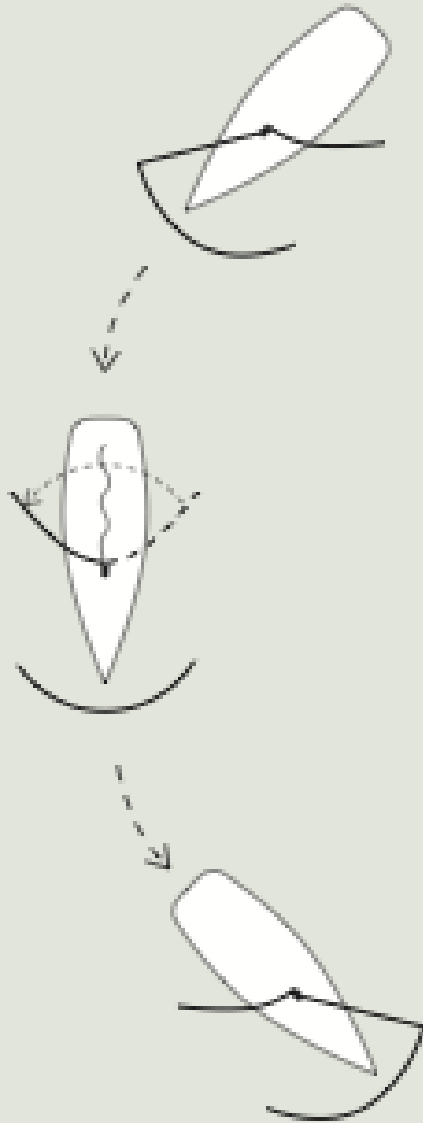

Jibb



Lens



Havnemanøvrering og fortøyning



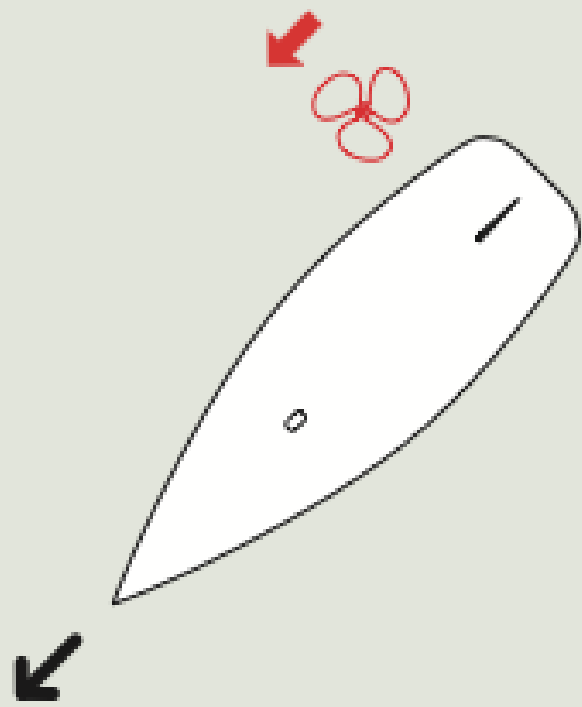
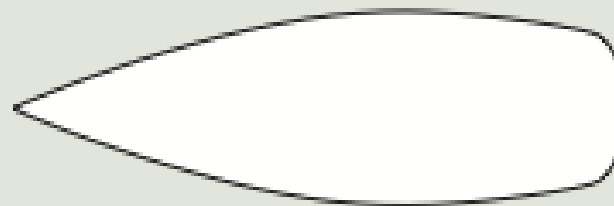
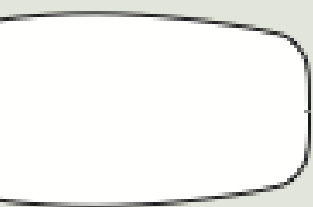

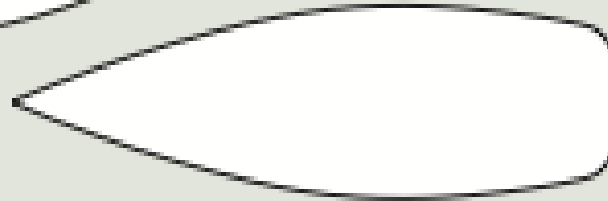
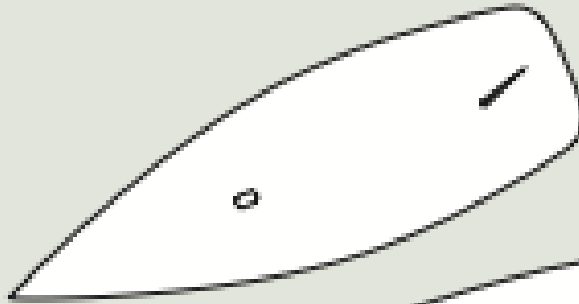
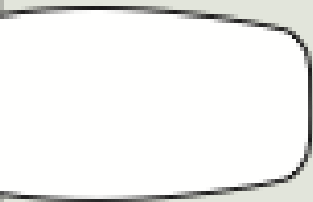

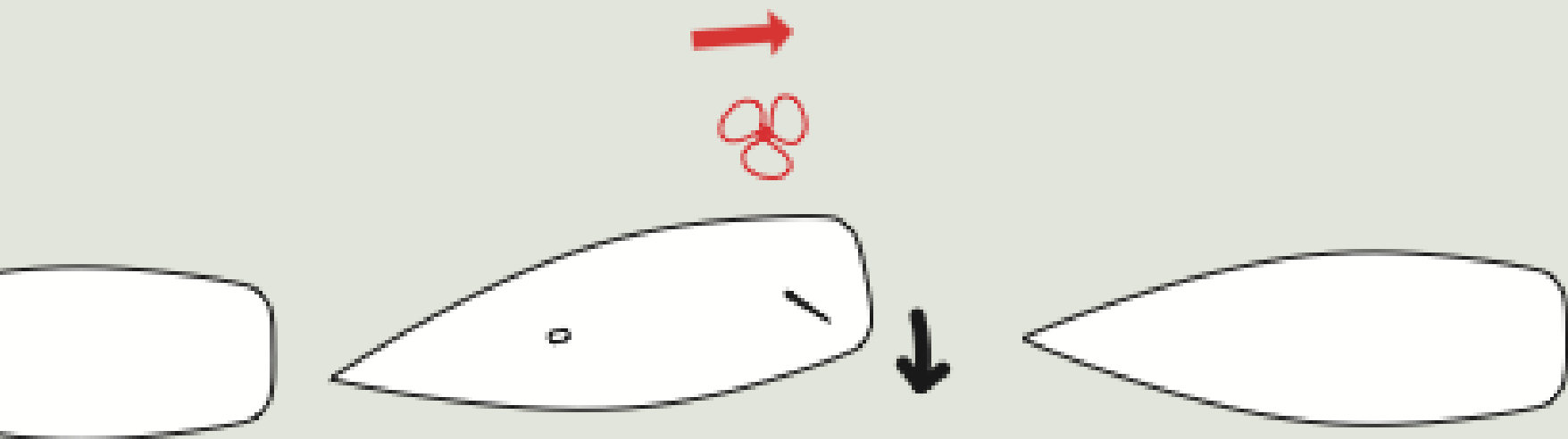

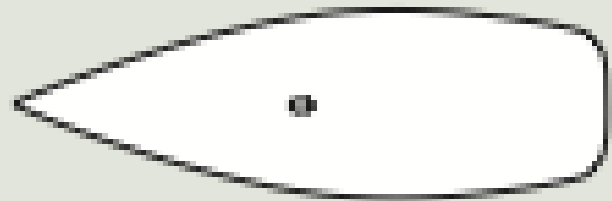
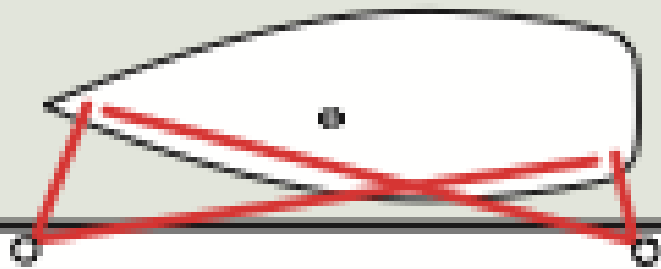

Reve storseil?



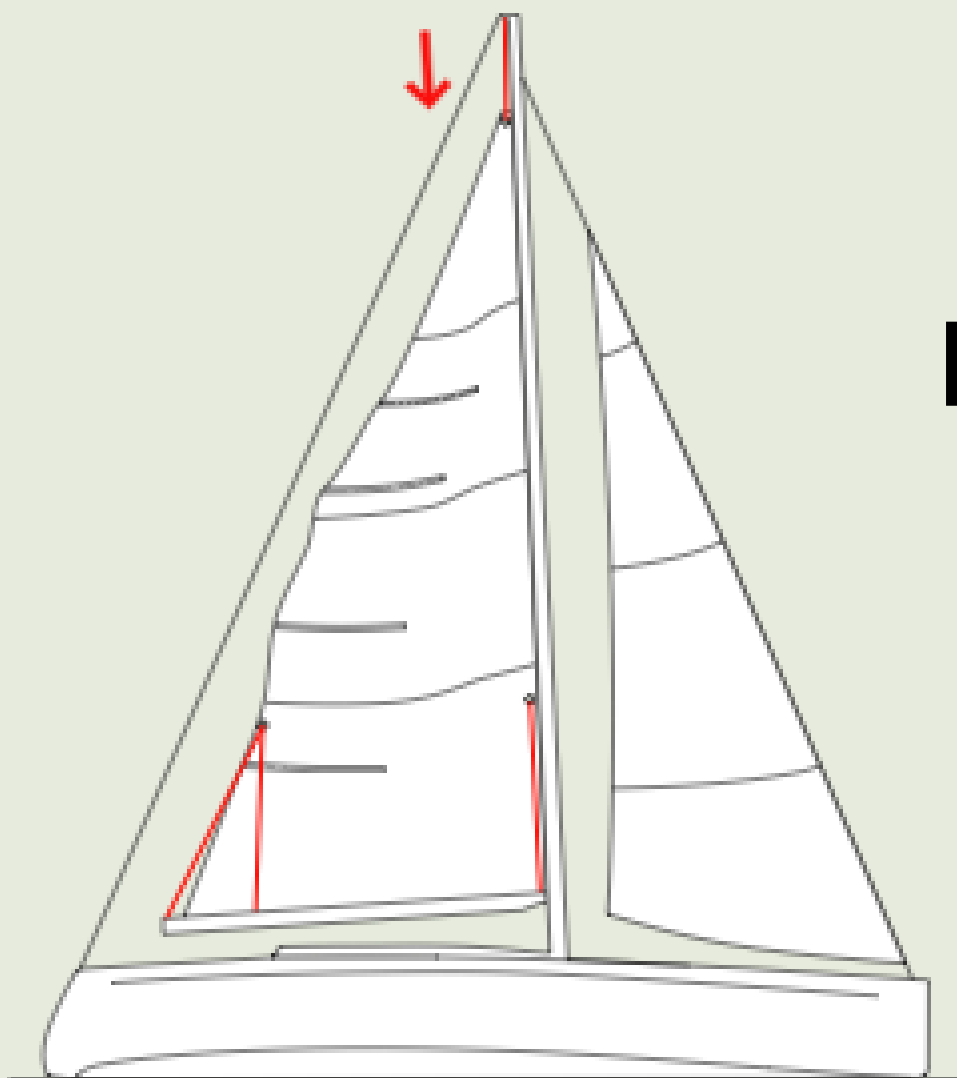

Løsne fallet



Fest revemaljen

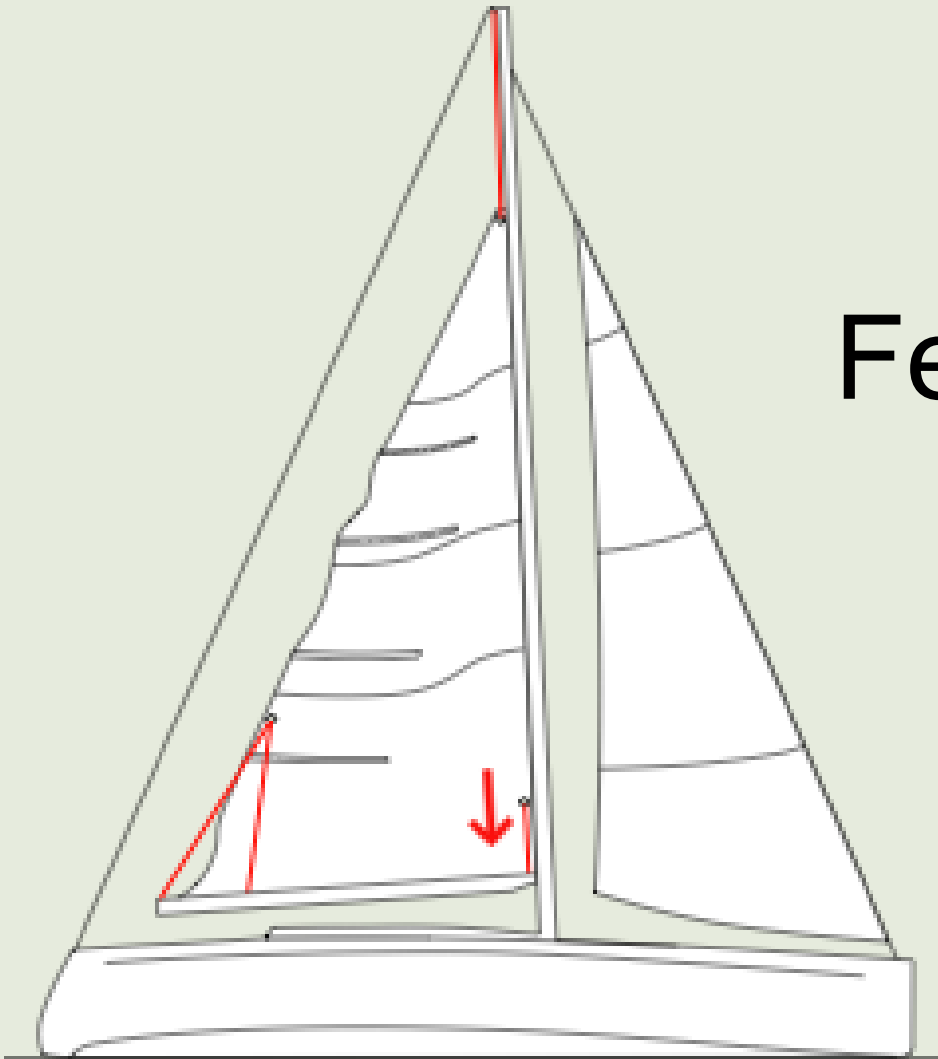

Stram fallet

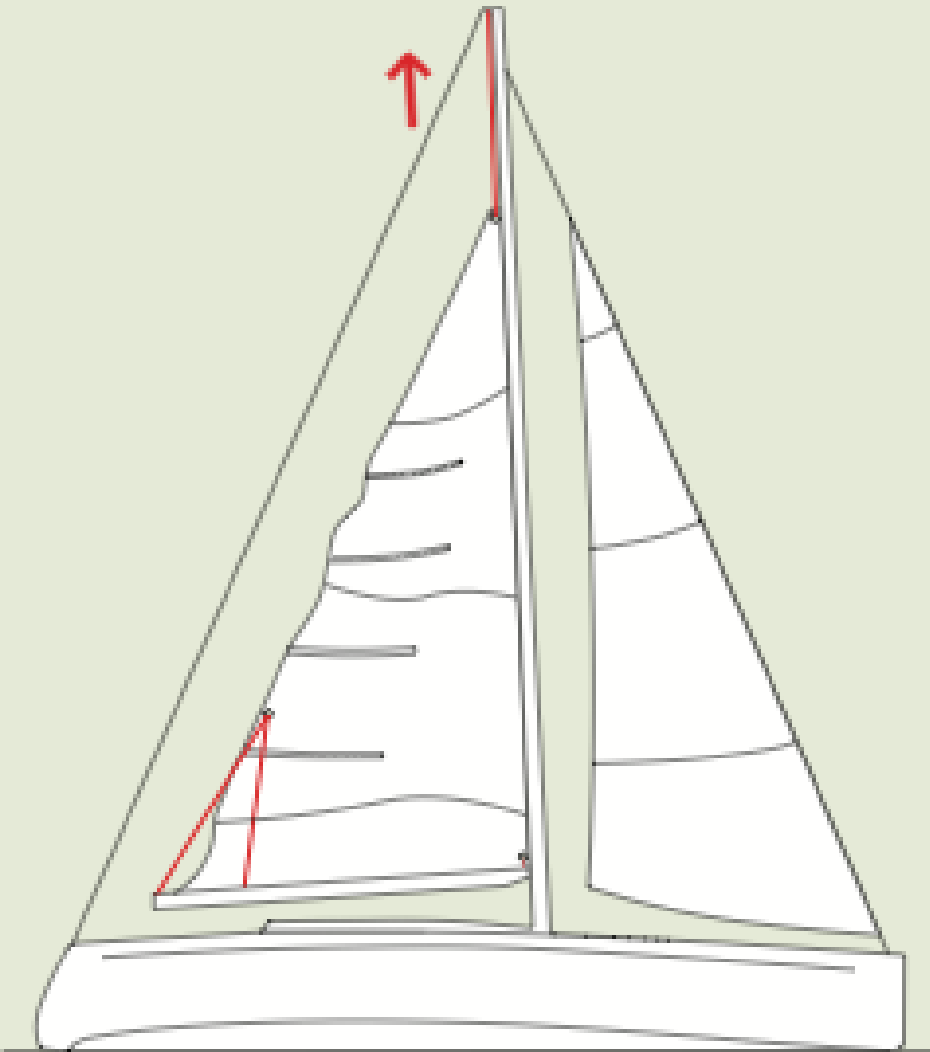

Stram revelinen

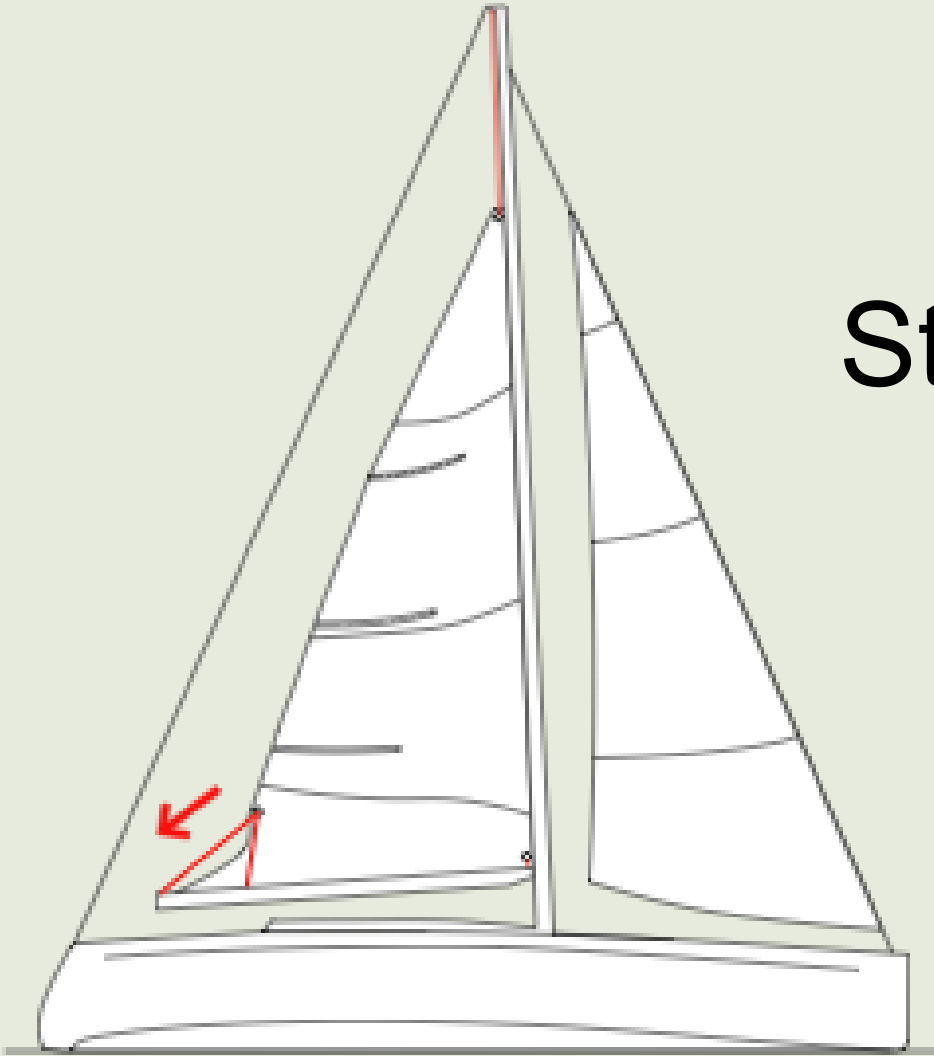

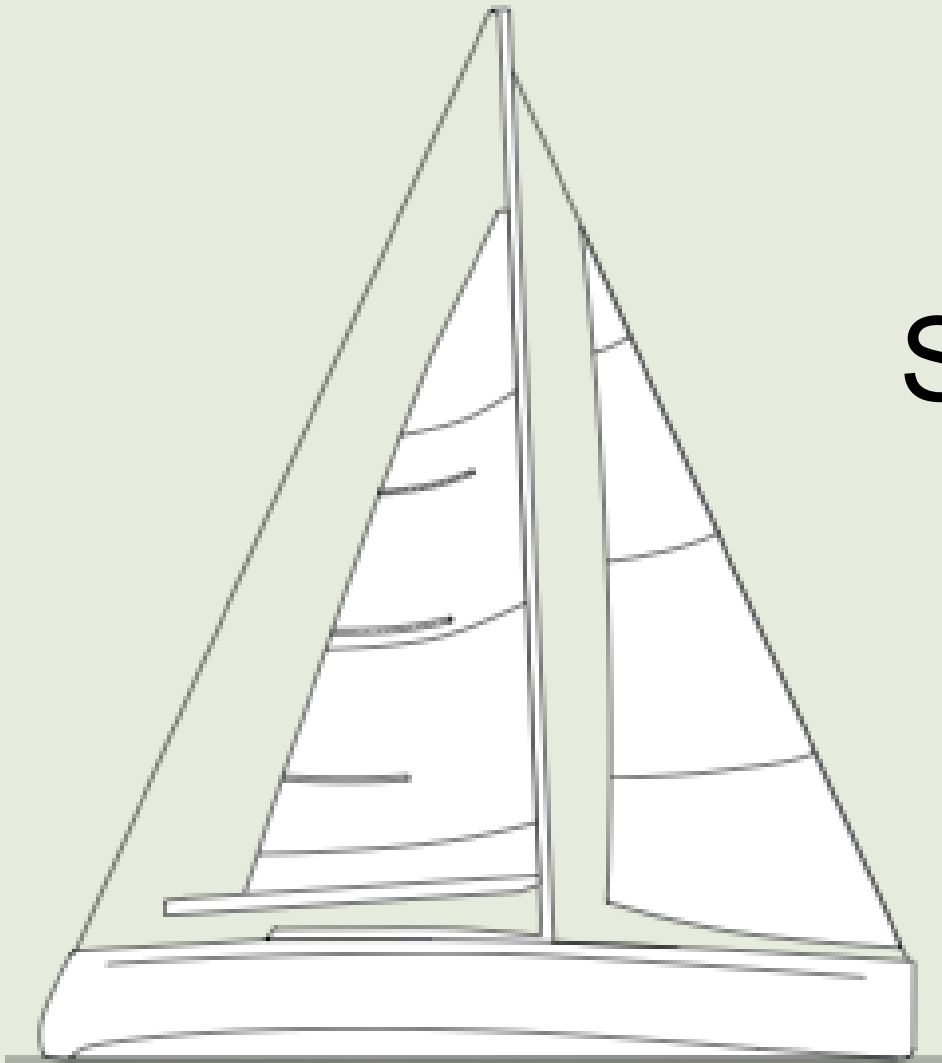

Seil videre :-)





- ⊗ Ikke fall i vannet
- ⊗ Ikke få bommen i hodet



Quick stop!



Regattaseiling



Entype



Handicap



Vind



Baner

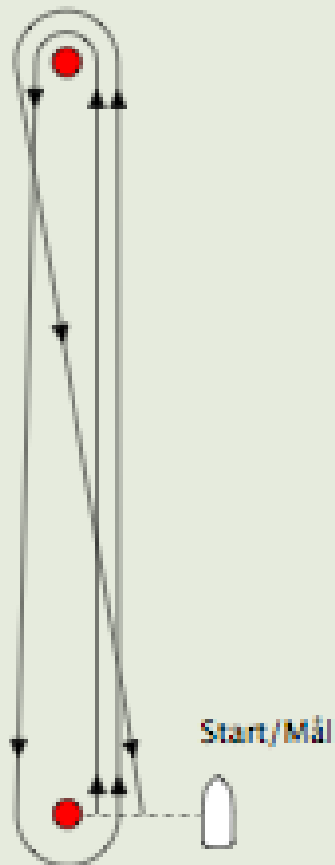

Pølsebane

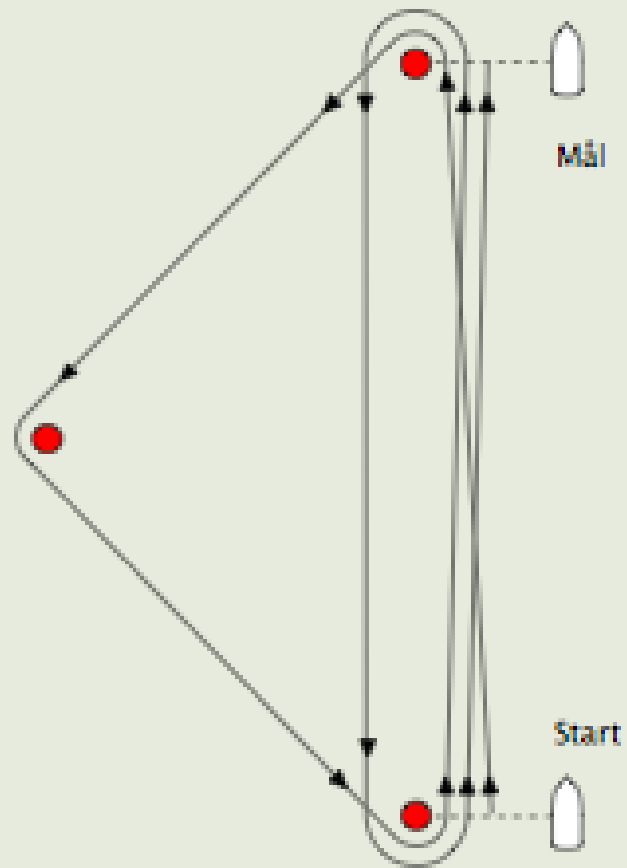

Trekantbane

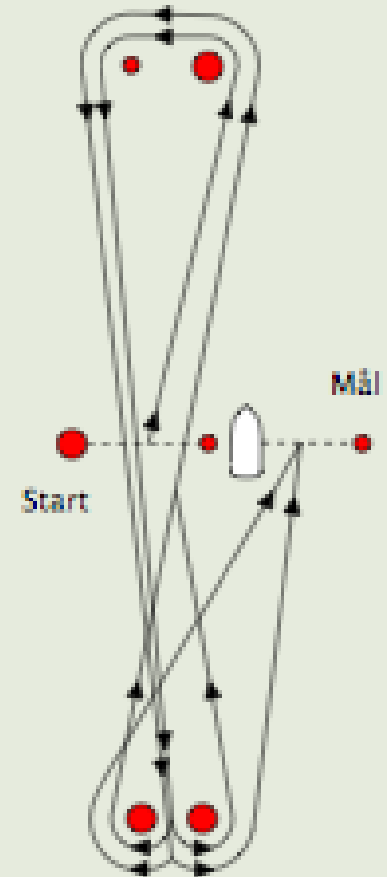

Pølsebane m/gate



Faste merker



Startprosedyre





Kappseilingsreglene

Vind

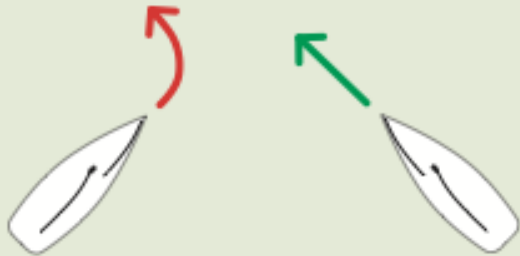

Babord halser

Styrbord halser

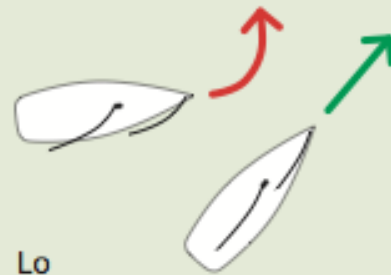

Lo

Le



Spinnaker og gennaker



Sette gennaker



Vind



Sette spinnaker

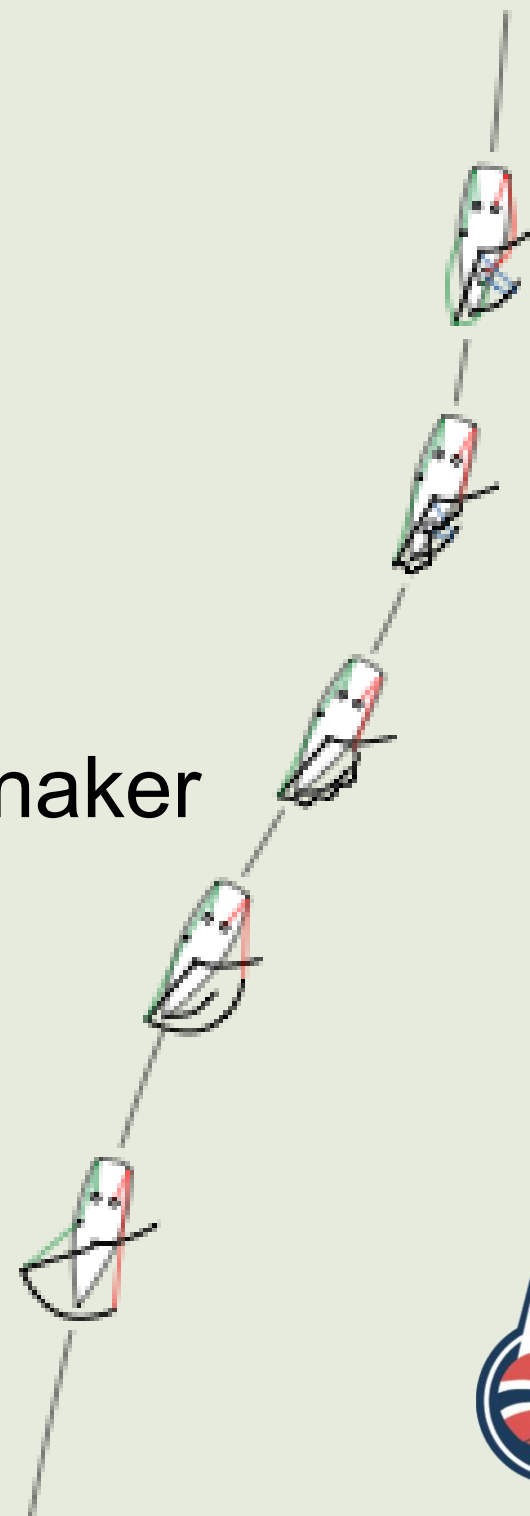

«prøv,
spør og
bli bedre!»

